

Mineral wool ceiling tiles OWAacoustic® smart

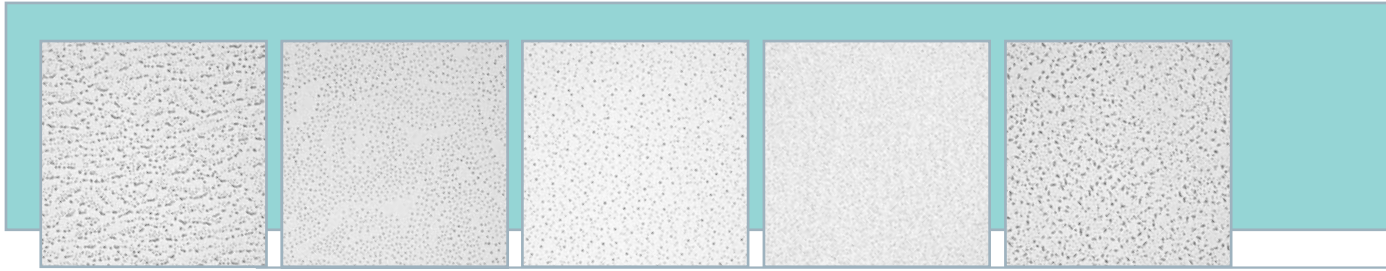

OWAacoustic® **smart**

Strength in standards

... simply smart



OWA

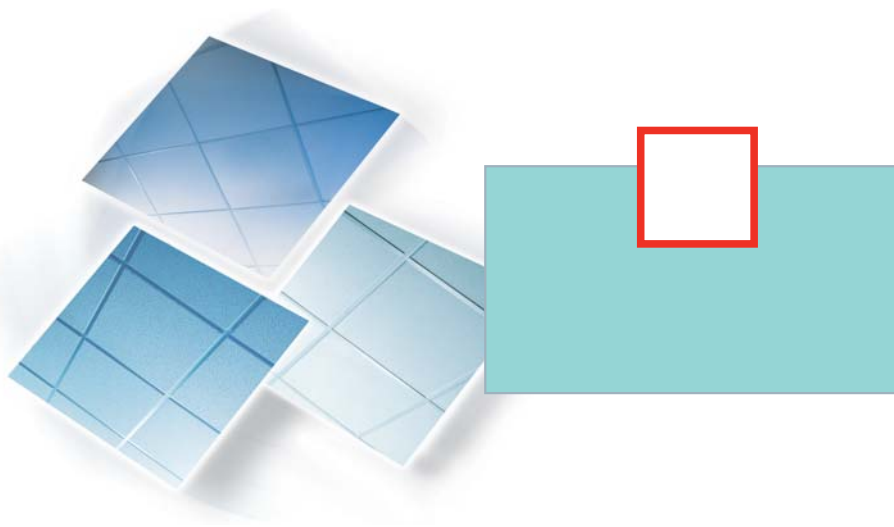

Mineral wool ceiling tiles OWAcoustic® smart:

Strength in standards

In response to market preference OWA has adjusted and improved its products.

OWAcoustic® smart sets new levels of performance in economy priced products.



- Humidity resistance up to 90 % relative humidity (90 RH)
- Reaction to Fire Class "O"
Approved document B Building Regulations A2-s1,d0 EN 13501-1
- 1 hour fire protection to BS 476 part 23
Up to REI 90 EN 13501-2
- Good acoustic absorption

Additional advantages:

The reduced thickness and density weight bring savings in handling and transport costs.

An aesthetical extra:

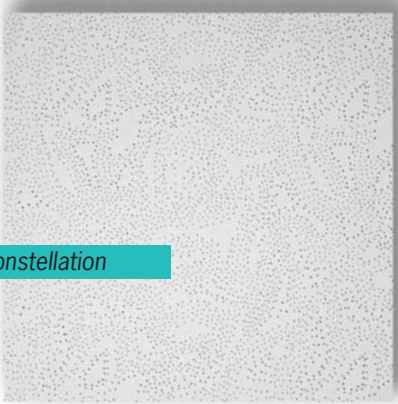
The available option of a 6 mm shallow cut reveal Contura edge (edge 7) gives an added – easy on the eye – aesthetical dimension that adds to the architectural appeal of an OWAcoustic® smart

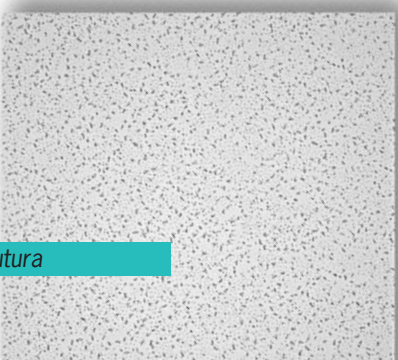
 <p>Harmony</p>	<p>$\alpha_w = 0,60$ (H) NRC = 0,65</p>
 <p>Constellation</p>	<p>$\alpha_w = 0,60$ NRC = 0,60</p>
 <p>Finetta</p>	<p>$\alpha_w = 0,60$ NRC = 0,60</p>
 <p>Sandila</p>	<p>$\alpha_w = 0,40$ NRC = 0,35 (needed) $\alpha_w = 0,10$ (L) NRC = 0,10 (unneeded)</p>
 <p>Futura</p>	<p>$\alpha_w = 0,60$ (H) NRC = 0,65</p>



Mineral wool ceiling tiles OWAcoustic® smart:

Edge 7 The slim reveal edge

Modern architecture shows a preference for plain structured shapes and elegant lines.

This new development of the Contura edge (Edge 7) introduces a 6 mm slim cut reveal edge that gives a refined detail to the overall ceiling installation.

Standard economy ceilings can now have the refinement of a Contura reveal edge detail.

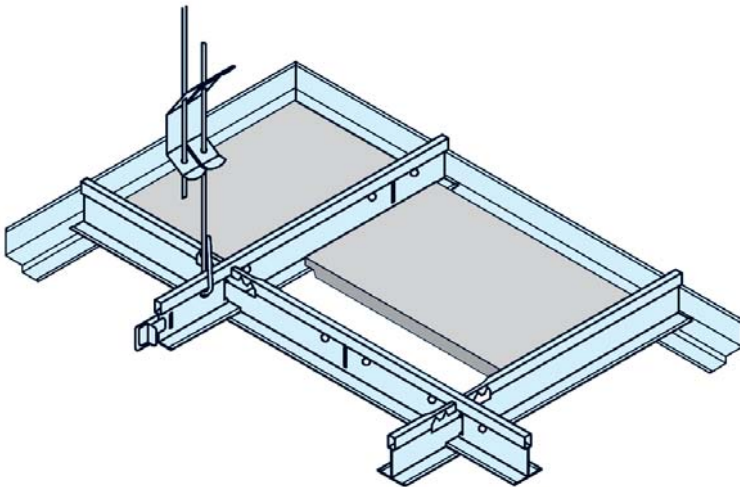

Fast in the warehouse, quick in the ceiling.

OWA can provide fast delivery to your warehouse, which means a quick response to your own customers' requirements.

With **OWAcoustic® smart** we have a quick reaction time – fast delivery when and where you need it – your warehouse or direct to site.

OWAcoustic® smart
+ OWAconstruct®
= tested security

Standard lay-in ceiling systems have the advantage that they are quick and simple to install but they are often required to meet specific technical compliance with official regulated technical standards.

The OWAconstruct® exposed grid system, combined with **OWAcoustic® smart** ceiling tiles, gives an easy to install economic performance ceiling with certified standards of fire protection and acoustics.

OWA suspension constructions with OWA ceiling tiles are certified throughout Europe. It makes sense to use complete systems from OWA.

... simply smart

OWAcoustic® smart

Strength in standards

Mineral wool ceiling tiles OWAcoustic® smart:

Technical Data

Face Patterns:

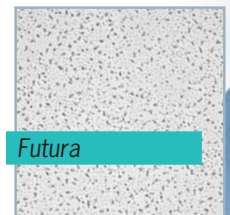
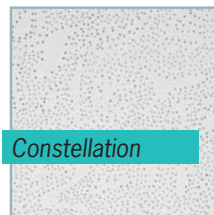

Dimensions:

600 x 600 mm	600 x 1200 mm
	300 x 1200 mm

Thickness: 14 mm nominal

Edges:



Square Cut



Contura

Systems:

S 3

S 3a (Edge 7)

Use Stepped Perimeter Trim No. 50/14
and Contura Filler Plugs No. 42/7

Reaction of Fire Class "O" Approved document B
Building Regulations, A2-s1,d0 EN 13501-1

1 hour fire protection to BS 476 part 23
Up to REI 90 EN 13501-2

OWA

Odenwald Faserplattenwerk GmbH
Dr.-F.-A.-Freundt-Straße 3
63916 Amorbach
Telefon: +49 9373 2 01-0
Telefax: +49 9373 2 01-1 30
www.owa.de · E-Mail: info@owa.de

Brochure No. **950/E**
070705